

RW-710F/910F

VER 001

Vehicle Weighing Scale

OWNER'S MANUAL

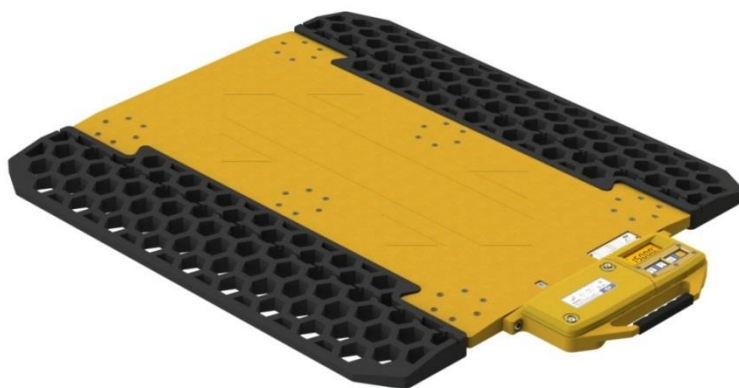



CAS

NOTE

- (1) The unauthorized copying of some or all of this manual is prohibited.
- (2) The information contained herein is subject to change without notice.
- (3) If there are any questions such as wrong or missing parts of the contents listed in this manual, please contact us.
- (4) To improve the product performance, functions can be changed with no notice.
- (5) Please understand that CAS does not have responsibility for a demand related to loss, lost profit etc. caused by operating the product, regardless of the third clause.

WARNING DEFINITIONS

	This is warning & caution mark
	This is hazard alert mark
	This is useful information mark

INDEX

1. Precautions	4
2. Introduction	5
3. Installation	5
4. Use of Battery Pack	7
5. Description of Panels and Symbols	8
6. Setting Mode	9
7. Test Mode	10
8. Specifications	11
9. Check Message	13

1. Precautions

 Please be informed that we're not responsible for any incident or mishap caused by partial modification of this product. To avoid such situation, customers need to contact our customer service team or system installation staff in advance, and any modification should be conducted under our surveillance.

◆ Use only approved enhancements and batteries. Do not connect incompatible products. Use only batteries, chargers, adaptor, and enhancements approved by CAS for use with this particular model.

The use of any other types may invalidate any approval or warranty, and may be dangerous. For availability of approved enhancements, please check with your dealer.

- ◆ Do not install the scale in strong direct sunlight and dust.
- ◆ Please confirm that the local voltage is correct for the power adaptor.
- ◆ Do not use inflammable substances for cleaning.
- ◆ Avoid sudden changes of temperature if possible
- ◆ Do not use the product in a place with a high-voltage current or severe electronic noise.
- ◆ Do not use the product in a place with severe vibration.
- ◆ Do not put too much pressure to keys.
- ◆ Avoid from the shock of excessive weight.



2. Introduction

- ◆ Easy to exchange the battery pack.
- ◆ Slim(34mm) type.
- ◆ Weigh-In-Motion(WIM)
- ◆ Outstanding water resistant(IP66) and vibration proof effect.
- ◆ Wireless communication: ZigBee
- ◆ Long battery lifetime by one time charging

3. Installation

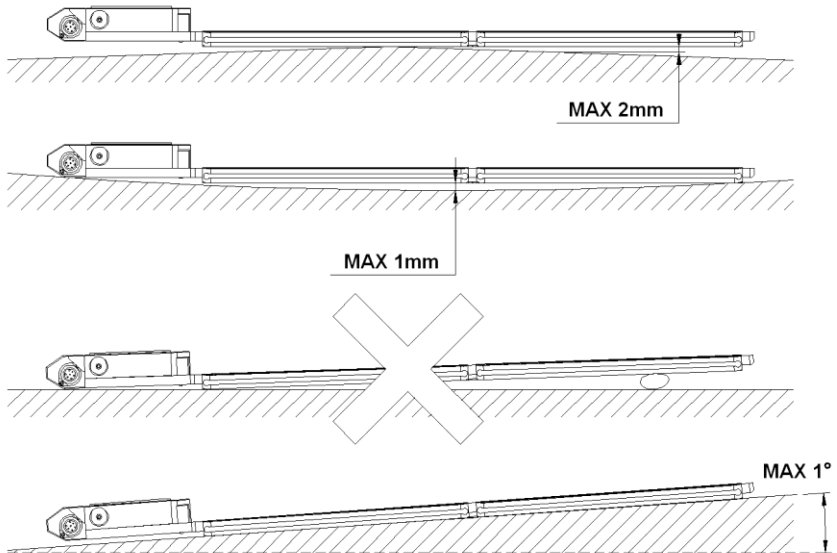
Be cautious of below situations, when placing the product on the road.

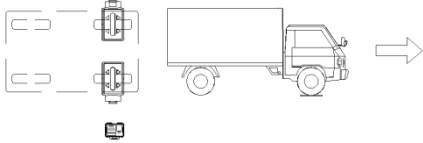
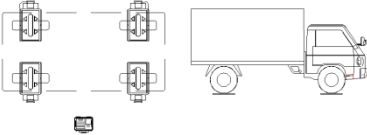

Weighing method	Description
<p><u>Sequential</u> 2 Axle, 2 Plate</p> <p>Accuracy: $\pm 1\sim 3\%$ (WIM: $\pm 3\%$)</p> <p>[Scale ID] Axle 1 \rightarrow Left: 1 / Right: 2</p>	 <p>⚠ In case of Weigh-In-Motion (WIM), you must install the dummy pad (longer to the length of the vehicle) back and forth on scale.</p>
<p><u>Synchronous</u> 2 Axle, 4 Plate</p> <p>Accuracy: $\pm 0.1\%$</p> <p>[Scale ID] Axle 1 \rightarrow Left: 1 / Right: 2 Axle 2 \rightarrow Left: 3 / Right: 4</p>	
<p><u>Synchronous</u> 3 Axle, 6 Plate</p> <p>Accuracy: $\pm 0.1\%$</p> <p>[Scale ID] Axle 1 \rightarrow Left: 1 / Right: 2 Axle 2 \rightarrow Left: 3 / Right: 4 Axle 3 \rightarrow Left: 5 / Right: 6</p>	 <p>i Can be installed up to maximum 6 axles</p>

i As shown above, if it is used with the indicator, please refer to indicator's operating manual.

4. Use of Battery Pack

Use only approved power adaptor and batteries.

Do not connect incompatible products.

Use only batteries, chargers, adaptor, and enhancements approved by CAS for use with this particular model.

The use of any other types may invalidate any approval or warranty, and may be dangerous. For availability of approved enhancements, please check with your dealer.

4.1. Battery charging

Step1. Turn clamps that exit on both sides of battery cover to the right in a quarter.

Step2. Pull out a battery pack.

Step3. Check the power adaptor voltage is (DC 5V, 1A).

Step4. Connect the charging jack to the **IN** port from adaptor.

Step5. If adaptor is still being charged, the RED lamp is on.

Step6. If a charging is completed, the RED lamp is off.

Step7. The battery charging time takes about 6~8 hr.

(Charging time is subject to be changed according to battery condition.)

Step8. Inserting is in reverse.

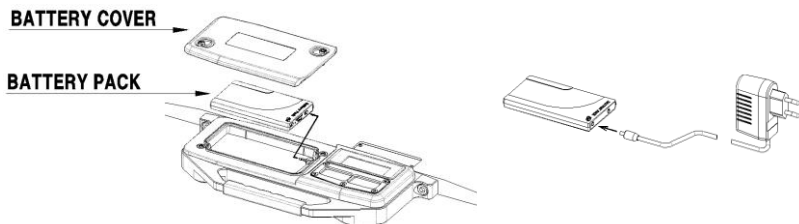

4.2. Battery lamp

In order to prevent the electric discharge, after r is on, the power will be turned off automatically after about 1~5 hours.

(It's subjected to be changed according to using conditions.)



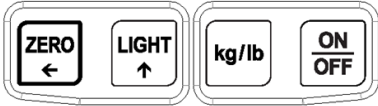



5. Description of Panels and Symbols















Display	
①②③④⑤⑥	Indicates the number of measured wheels in the WIM mode.
000000	Indicates weight and status
📶	Indicates the status of the wireless connection
⊖	Displayed when the weight is minus
🔋	Indicates when a battery has to be recharged
ZERO	Displayed when the weight is zero
▼	Indicates in-motion mode
kg lb	Indicates the weighing unit
○	Displayed when the weight is stable

Key	
ON/OFF	Turn on and off the scale.
ZERO ←	Return the display to zero
LIGHT ↑	Use to back light on and off
kg/lb	Use to change weight unit ⚠️ Wireless linked product's unit is also changes

6. Setting Mode

How to enter	When the display is off, press  key while pressing  key then this setting mode is started.
Used keys	 : Used to set up an initial zero value / Increase the digit of value (F03)  : Used to increase the setting constant one by one.  : Used to move next menu after completing input value.
F01 5	Adjustment the speed of weight change (1~9) ex) F01-1: Very fast ~ F01-9: Very slow
F02 0	Automatic zero condition (0~9) ex) F02-0 : Not used F02-3: Compensation for gradual change below 1.5division. F02-9: Compensation for gradual change below 4.5division.
F03 1	Scale ID number (1~12) ex) F03-1: ID 1 ~ F03-12 : ID 12
F04 0	Weighing-In-Motion (WIM) (0, 1) ex) F04-0: Not used / F04-1: Used <div style="background-color: #e0e0e0; padding: 2px;">In the WIM mode</div> When "SL0", "FAST" message occurs, in order to initialize, press  key. Then, must be measured weight again. Maximum vehicle speed: 10km/h (6mi/h)
F05 5	Adjusting the brightness of the backlight (0~9) ex) F05-0: 10% brightness ~ F05-9: 100% brightness

7. Test Mode

<p>How to use</p>	<p>When the display is off, press  key while pressing  key then this test mode is started.</p>
<p>Used keys</p>	<p> : Used to test the scale. : Used to move next menu.</p>
	<p>TEST 1 : Display test It operates automatically and the whole display is ON.</p>
	<p>TEST 2 : Key test Initial display is '0'. Press a key that you want to test, and then the display message will be shown. (:1 / : 2 / : 3)</p>
	<p>TEST 3 : Load cell test The value is the conversion constant for A/D. The value may be different according to scale models. Please check if the displayed number is easily changed with giving force to a scale. If the displaying number is not changed or remains '0', then it needs the service after sales.</p>
	<p>TEST 4 : Back light test : Turn on and off the back light.</p>

8. Specifications

◆ General specification

Capacity	10,000kg / 20,000lb
Division	10kg / 20lb
Safe overload	150% of capacity
Display	5 digit FSTN LCD (Height: 15mm)
Backlight	Amber LED backlight
Load cells	6 Standard 750Ω Bridge
Output data rate	10 times/sec(Static), 100 times/sec (WIM)
Operating temperature	-20℃ ~ 60℃
Operating humidity	85% R.H. (No condensation)
Net weight	Approx. 28kg
Ramp weight	2.6kg x 2pcs
Power	3.7V \pm 4A Lithium polymer battery
Charging adapter	AC/DC Adapter 5V \pm 1A
Operating time	Approx. 60hr

◆ Wireless specification

Wireless method	ZigBee
RF frequency range	2400 ~ 2483.5 MHz
Output power	Max. 4dBm
Channel width	2 MHz
Frequency offset	< \pm 30ppm
Transmit data rate	250Kbps,500Kbps
Receiver sensitivity	-99dBm (PER <1%)
Maximum input level	0dBm
RF In/out impedance	50 ohm (TXRF, RXRF)
Spurious(2nd harmonics)	< -30dBm
Radio link effective range	Approx. 30M (Open space)

Vehicle Weighing Scale RW-710F/910F

◆ Dimensions [mm]

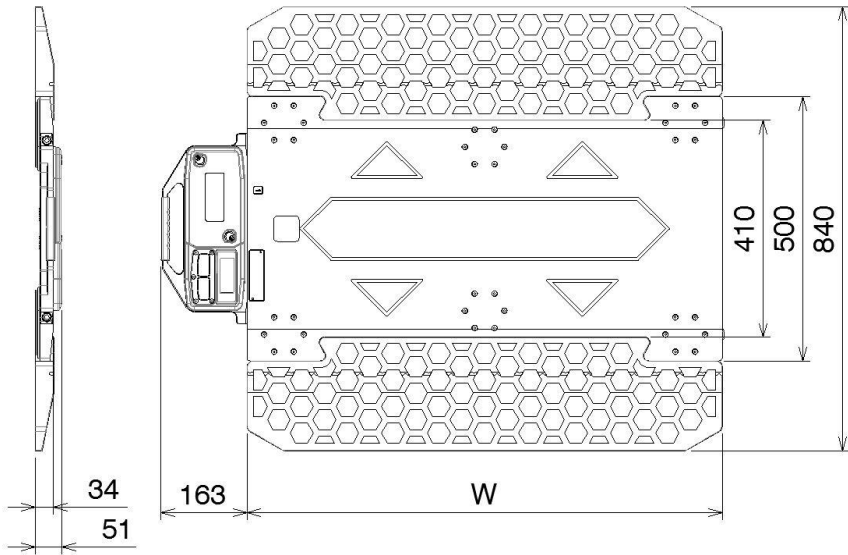

W: RW-910F 900mm / RW-710F 700mm

9. Check Message

Code	Description
<i>Ch 02</i>	Something wrong in a load cell connection or in an A/D convertor. Please check the load cell and then contact us to resolve this technical problem.
<i>FAST</i>	In the WIM, occur when the vehicle's speed is too fast. Please pass the vehicle with 10km/h(6mi/h) or less.
<i>SLo</i>	In the WIM, occur when the vehicle's speed is too slow.
<i>ouEr</i>	The scale's weight is over maximum capacity. Don't load the article whose weight is heavier than the maximum capacity.

[MEMO]